

Thank you for your purchase of our gas stove. Please read these instructions carefully before using, and keep them in a safe place for future reference.

FEATURES

- Auto ignition with japanese piezo
- 8mm tempered glass cooktop
- Heavy cast iron mixing tube
- Indian brass burners
- Low gas consumption

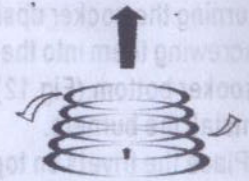

NAMES OF PARTS

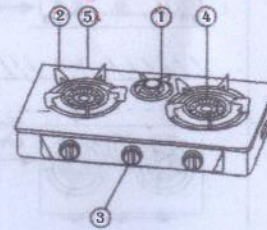

1. Small burner
2. Trivet
3. Gas control knob for small burner
4. Brass cap
5. Back panel

BEFORE USE

1. Confirm that you have the right model for your type of gas supply.
2. When unpacking, make sure that all spares of the gas stove are included. assemble the parts as show in. (Fig. 9)
3. Place the gas control knob onto the gas cock axis and push it inwards firmly. (Fig. 10)(Fig. 11)
4. Attach the rubber leg to the stove by turning the stove upside down and screwing them into the openings on the sooker bottom. (Fig. 12)
5. Install the burners.
6. Place the trivets on top of the burner. the trivet can be adjusted but turning the screws and then the pan can be put On the trivets steadily.
7. Push the rubber hose onto the hose joint as far as it will go. Do not use a vinyl plastic hose, as this can be dangerous. secure the hose with both sides of hose clamp. (Fig. 13) see to it that the rubber hose does not touch a part of the gas stove nor lies underneath it.
8. When choosing a place to put the gas stove, be sure to pick a spot that is firm and level. The gas stove need plenty of space and air. Allow at least 15cm of space on the sides and 100cm above the unit. (Fig. 14) if the space is less Than 15cm from the in-flammable walls, be sure to provide a heat insulation board. also be sure to keep paper, oil, and all other inflammable objects away from the gas stove.

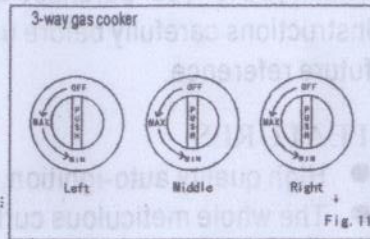

Fig. 11

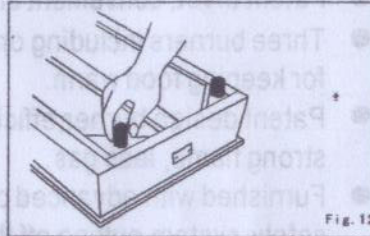

Fig. 12

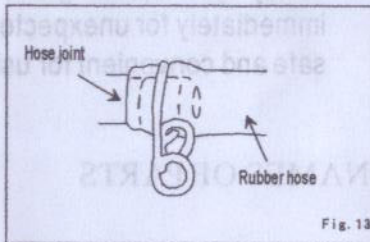

Fig. 13

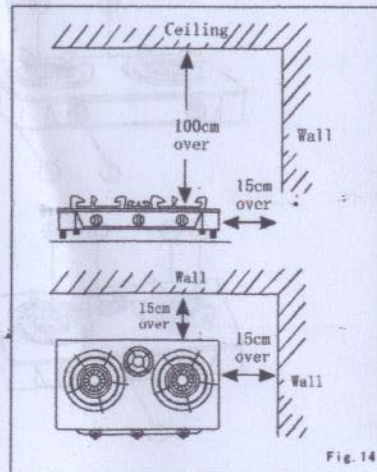

Fig. 14

occasionally. Keep it away from heater sources, and keep it clean.

- Wipe the stainless steel top and body with a dry cloth, if it is difficult to clean, use soapy water and then dry thoroughly with a dry cloth.
- Wash the trivet in water thoroughly before replacing.
- The electronic ignition will not function if it is wet. Be careful not to spill water, soup, etc. On it. (Fig. 20)
- For better service and a longer service life, keep the gas cooker clean.

TROUBLE-SHOOTING GUIDE

TROUBLE	CAUSE	REMEDY
It does not ignite.	<ul style="list-style-type: none"> ● Main gas valve remains closed. ● Rubber hose is bent. ● No gas supply. ● Electronic ignition is wet. 	<ul style="list-style-type: none"> ● Open it. ● Put it right, or replace it. ● Replace gas cylinder. ● Clean and dry them.
It smell of gas.	<ul style="list-style-type: none"> ● Gas leak from pipe. ● Rubber hose is damaged. ● Burner is not lit. 	<ul style="list-style-type: none"> ● Examine pipe using soap water, and replace it. ● Replace it. ● Re-ignite it.
Combustion is abnormal	<ul style="list-style-type: none"> ● Lack of gas supply. ● Flame ports are clogged. ● Burner is not in its correct position. 	<ul style="list-style-type: none"> ● Replace gas cylinder. ● Clean them. ● Place it right position.

AFTER-SALE SERVICE

- When you find something wrong with your gas stove, make checkups by referring to the "trouble-shooting guide". If you can not find out the cause of the trouble from such, get into contact with your dealer.



Automatic Gas Stove

Printed on recycled paper

Keep your environment clean

INSTRUCTION MANUAL

AUTOMATIC GAS COOKER

CAUTION

- Do not use a gas other than that which is specified on the label attached. (Fig. 1)
- Use for cooking only. Do not dry towels, clothes, etc., over it. (Fig.2)
- To avoid damage, do not place charcoal on the burner.
- Avoid covering the flame with a big plate which covers the gas stove
- Do not use the gas cooker where the flame may be blown off by the wind.
- Make sure that there are no inflammables near the gas stove. (Fig.3)
- Use only a rubber hose. do not use a vinyl plastic hose, as this can be dangerous. (Fig.4)
- While it is in use, see, from time to time, whether it burns normally.
- After use, turn the ignition knob back to OFF position and make sure the burner is put out. (Fig.5)
- When going to bed or leaving the house, be sure to turn off not only the ignition knob but also the main gas valve as well.
- The main gas valve not in use should be closed and covered by the cap.

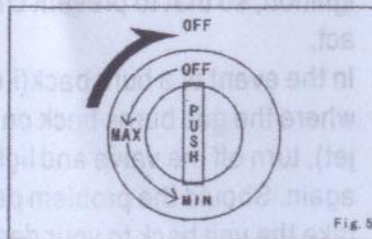
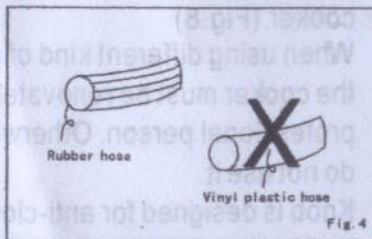
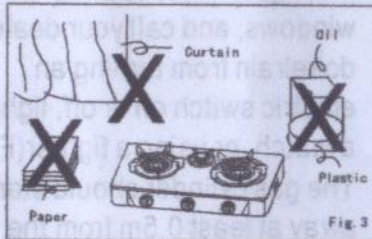
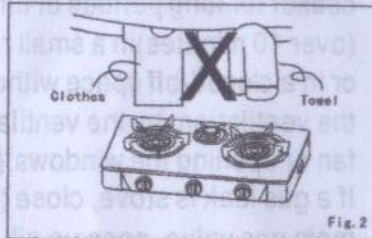
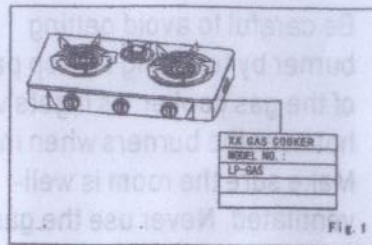

HOW TO USE

1. To light the burners:
 - a. Open the main gas valve. Push the gas control knob in and turn it towards the MAX position (counter-clockwise) until you hear the ignition click. Make sure that the burner has been lit. (Fig. 15) in this position, double burner will light up both the same and large burners, To use only the small burner, release the gas control knob and turn it further to the MIN position. (Fig. 16)
 - b. To adjust the flame size, set the gas control knob to a suitable position between MAX (full flame size) and MIN position (small flame size)

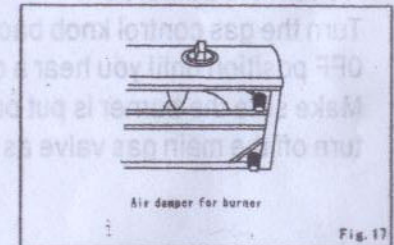
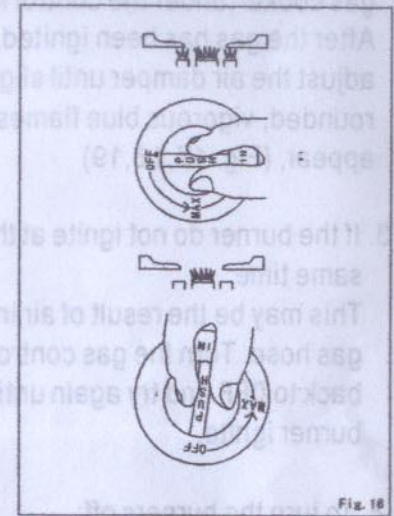
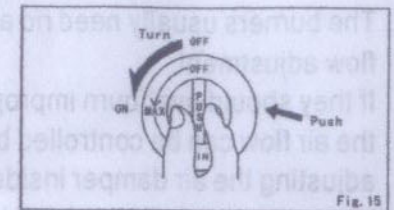

2. Air flow adjustment:

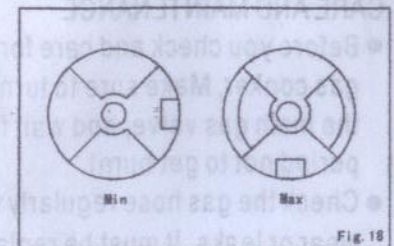

The burners usually need no air flow adjustment.

If they should ever burn improperly, the air flow can be controlled by adjusting the air damper inside the gas cooker (under the control knob). After the gas has been ignited, adjust the air damper until slightly rounded, vigorous blue flames appear, (Fig. 17, 18, 19)

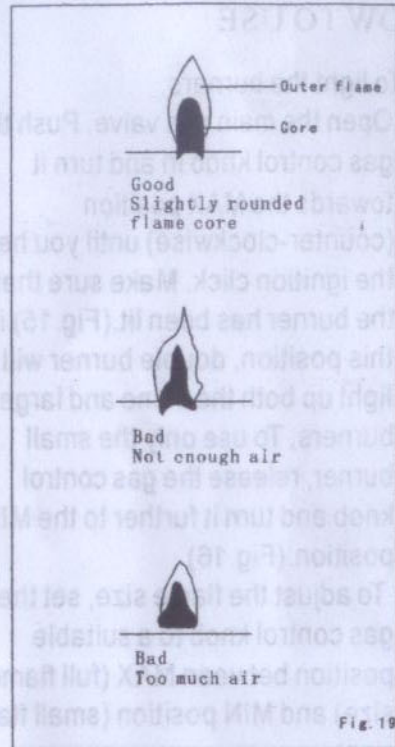

3. If the burner do not ignite at the same time:

This may be the result of air in the gas hose. Turn the gas control knob back to OFF and try again until the burner ignite.

4. To turn the burners off:

Turn the gas control knob back to OFF position until you hear a click, Make sure the burner is put out and turn off the main gas valve as well.

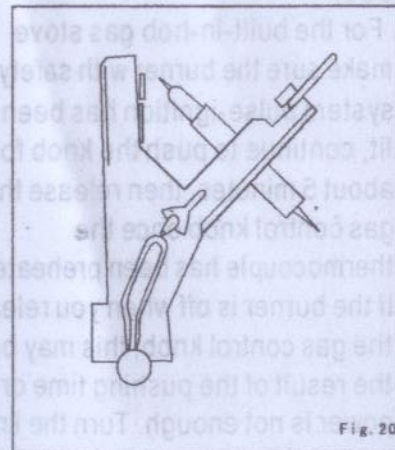

CARE AND MAINTENANCE

- Before you check and care for your gas cooker, Make sure to turn off the main gas valve, and wait for a period not to get burnt.
- Check the gas hose regularly for wear or leaks. It must be replaced

- Be careful to avoid getting burner by touching the top panel of the gas stove, as it gets very hot near the burners when in use.

- Make sure the room is well-ventilated. Never use the gas cooker for long periods of time (over 10 minutes) in a small room or in a closed-off space without the ventilation, by the ventilation fan or opening the windows. (Fig.6)

- If a gas leak is stove, close the main gas valve, open up all windows, and call your dealer. do refrain from turning an electric switch on or off, lighting a match, or using a fighter (Fig.7)

- The gas cylinder should stand away at least 0.5m from the stove. (Fig.8)

- When using different kind of gas, the cooker must be renovated by professional person. Otherwise, do not use it.

- Knob is designed for anti-clockwise ignition, so that to prevent children act,

- In the event of a burn back (i.e. where the gas burns back on the jet), turn off the valve and light again. Should the problem persist take the unit back to your dealer for checking.

